

SPECIFICATIONS

DIAMETER:	15" (381.0 mm)
SENSITIVITY (2.83 V @ 1M):	92 dB
POWER HANDLING:	800 W _{RMS} , 5,000 W _{PK}
FREQUENCY RESPONSE:	20 Hz ~ 1 kHz
NOMINAL IMPEDANCE:	6 OHMS (PER COIL)
VOICE-COIL DIAMETER:	3.0" (76.2 mm)
BASKET DISPLACEMENT:	0.130 FT ³ (3.680 LITERS)

DIMENSIONS:

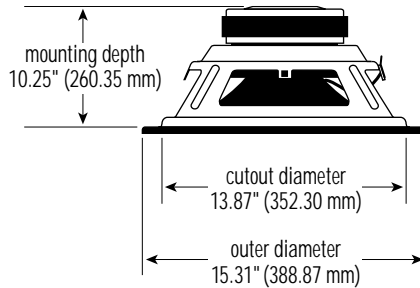

THIELE-SMALL PARAMETERS

VOICE COIL DC RESISTANCE:	R _{EVC} (OHMS)* 2.95
VOICE COIL INDUCTANCE @ 1 kHz:	L _{EVC} (MH)* 1.06
DRIVER RADIATING AREA:	S _D (FT ²) 0.839
	S _D (M ²) 0.078
MOTOR FORCE FACTOR:	BL (TM)* 15.39
COMPLIANCE VOLUME:	V _{AS} (FT ³) 4.67
	V _{AS} (LITERS) 132.20
SUSPENSION COMPLIANCE:	C _{MS} (μM/N) 153.02
MOVING MASS, AIR LOAD:	M _{MS} (GRAMS) 260.67
MOVING MASS, DIAPHRAGM:	M _{MD} (GRAMS) 248.15
FREE-AIR RESONANCE:	F _S (Hz) 25.20
MECHANICAL Q:	Q _{MS} 7.20
ELECTRICAL Q:	Q _{ES} 0.51
TOTAL Q:	Q _{TS} 0.48
MAGNETIC-GAP HEIGHT:	H _{AG} (IN) 1.00
	H _{AG} (MM) 25.40
VOICE-COIL HEIGHT:	H _{VC} (IN) 2.60
	H _{VC} (MM) 66.04
MAXIMUM EXCURSION:	X _{MAX} (IN) 0.80
(ONE-WAY LINEAR)	X _{MAX} (MM) 20.32

*VOICE COILS CONNECTED IN PARALLEL

SEALED BOX VOLUME (INCLUDES DRIVER DISPLACEMENT)

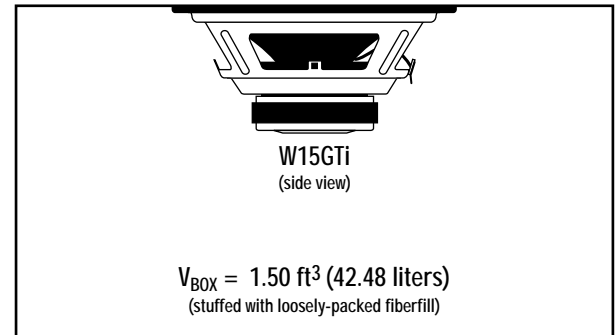

SEALED FREQUENCY RESPONSE @ 2.83 V

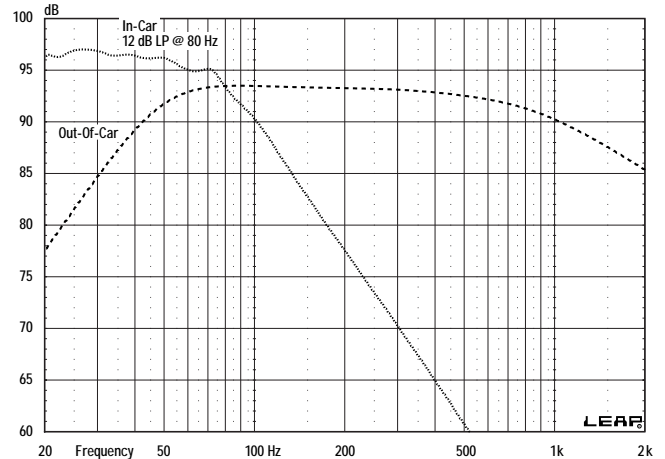

SEALED TRANSDUCER EXCURSION @ 3200 W

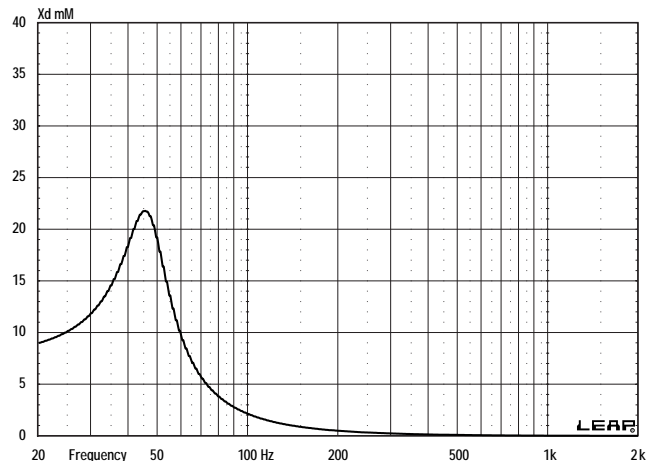



W15GTi 15" Woofer – Technical Data

VENTED BOX VOLUME (INCLUDES DRIVER/PORT DISPLACEMENTS)

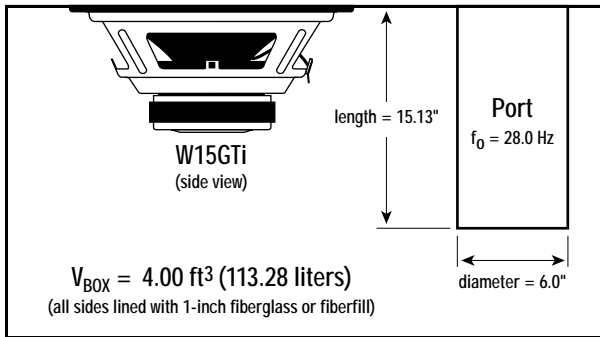

SEALED BANDPASS BOX VOLUME (INCLUDES DRIVER/PORT DISPLACEMENTS)

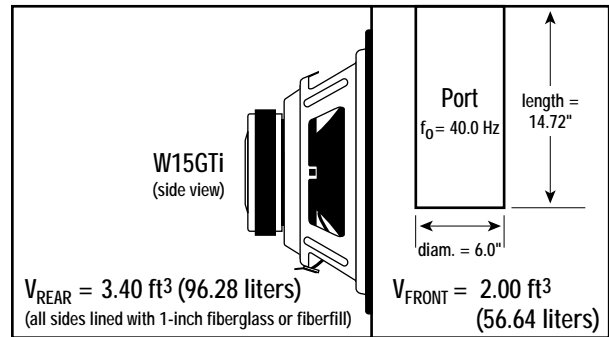

VENTED FREQUENCY RESPONSE @ 2.83 V

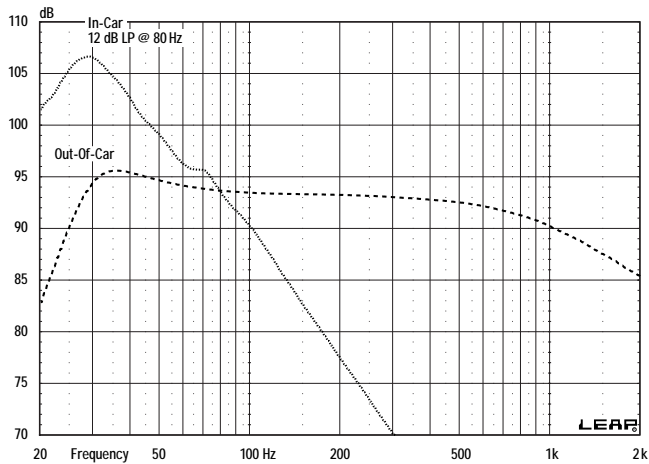

SEALED BANDPASS FREQUENCY RESPONSE @ 2.83 V

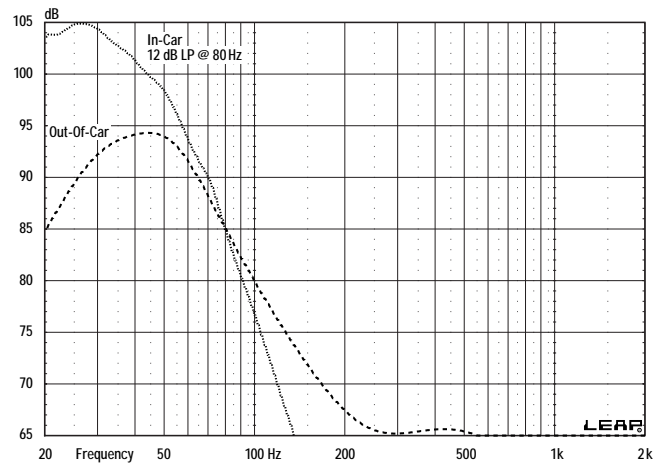

VENTED TRANSDUCER EXCURSION @ 3500 W

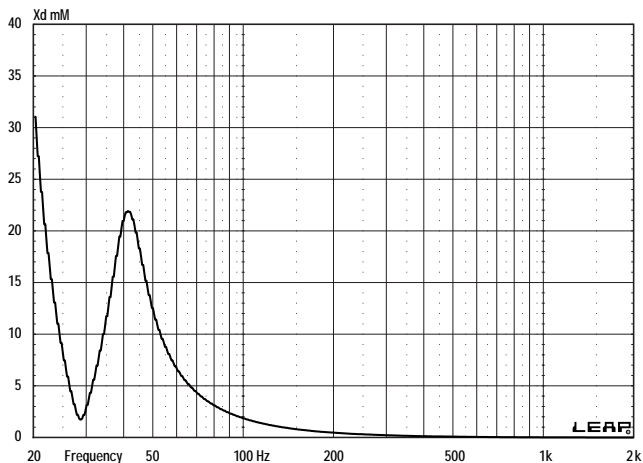

SEALED BANDPASS TRANSDUCER EXCURSION @ 2500 W

