

JBL AS-6 JBL Loudspeaker Troubleshooting/Repair Tips

Most Customers prefer to do simple loudspeaker repairs themselves. By following the steps below, most loudspeakers can be returned to their original factory performance with minimum effort. Choose the scenario that best describes the problem you are experiencing.

Problem 1: No sound/distorted sound from one loudspeaker in a pair (or set)

Connect the dead/distorting loudspeaker to a different amplifier channel (one that had a functioning loudspeaker connected to it). If it functions normally, the problem is not loudspeaker related. If the loudspeaker still makes no sound or sounds distorted: a wire may have become loose or disconnected, the network (also known as a crossover) may be defective, the drivers (woofer, tweeter, etc) may be defective, or in very rare cases, all may be defective.

Refer to the wiring diagram and exploded view below. The network is a small circuit board found on the inside of the terminal cup, or mounted to an inside wall of the enclosure. It sends low frequency sounds to the woofer, high frequency sounds to the tweeter and (if applicable) mid frequency sounds to the midrange driver. Make sure all wires are secure and connected. Look for components on the network that look burnt, "bulged", or abnormal. If these conditions are normal, connect the network to the drivers from another matching loudspeaker. **MAKE SURE** you attach the correct wires to each driver - mid and low frequency sounds can damage the tweeter! If there is still no sound or distorted sound, the network is defective. If there is clean undistorted sound, the drivers are defective.

Problem 2: No sound or distorted sound from one or more (but not all) drivers in an enclosure

Remove the offending driver(s) from the enclosure and make sure all wires are secure and connected. If they were, proceed with the following test:

Woofer or midrange driver: Connect the driver's + and - input terminals directly to the loudspeaker wires from your receiver/amplifier and play some music at a reasonable volume. If the driver now sounds normal (produces a clean undistorted sound), the network is most likely defective.

Tweeter: Replace the tweeter with a functioning tweeter from another loudspeaker. If the tweeter now functions normally (produces clean undistorted sound), the original tweeter was defective. If the replacement tweeter also sounds distorted or produces no sound, the network is most likely defective.

Problem 3: Loudspeakers distort, rattle or pop at higher volumes.

This is usually NOT a loudspeaker problem. Common causes are too much power (playing the loudspeakers too loud and causing them to distort), an amplifier with not enough power (the amplifier can't produce the required volume without distorting), excessive equalization (turning the tone controls too far clockwise, and/or engaging the loudness/bass boost button on your receiver) or some combination of the above. If only one loudspeaker is exhibiting the problem, and you're confident that it's not caused by too little power/too much power/excessive equalization, see solutions for Problems 1 or 2.

WIRING DIAGRAM

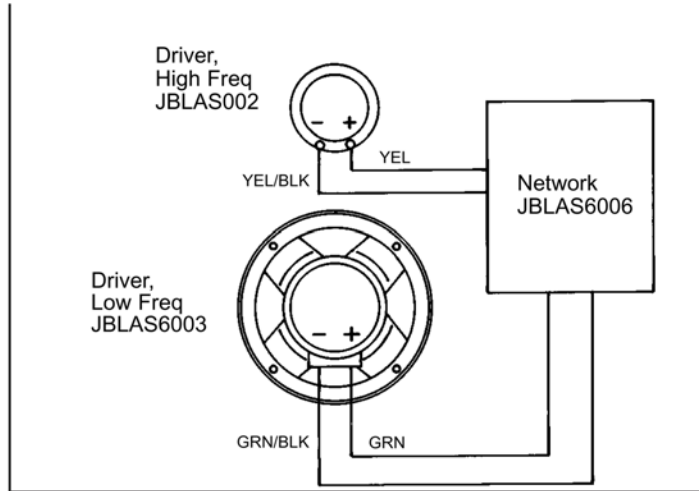

COMPONENT EXPLODED VIEW

