

The JBL logo is rendered in a bold, black, sans-serif font. The letter 'J' is stylized with a downward-pointing triangle above its top bar and a solid black circle at its base. The letters 'B' and 'L' are also bold and sans-serif.

®

STUDIO™ SERIES

L226W, L226C, L228C,
LS326W, LS326C, LS328C

OWNER'S GUIDE

THANK YOU FOR CHOOSING JBL, INC.

For more than 60 years, JBL, Inc. has been involved in every aspect of music and film recording and reproduction, from live performances to the recordings you play in your home, car or office.

We're confident that the JBL® speakers you have chosen will provide every note of enjoyment that you expected – and that when you think about purchasing additional audio equipment for your home, car or office, you will once again choose JBL products.

Please take a moment to register your product on our Web site at www.jbl.com. It enables us to keep you posted on our latest advancements, and helps us to better understand our customers and build products that meet their needs and expectations.

UNPACKING THE SPEAKERS

Carefully unpack the speakers. If you suspect damage from transit, report it immediately to your dealer and/or delivery service. Keep the shipping carton and packing materials for future use. All models include a mounting template and paint shield.

PLANNING YOUR SYSTEM

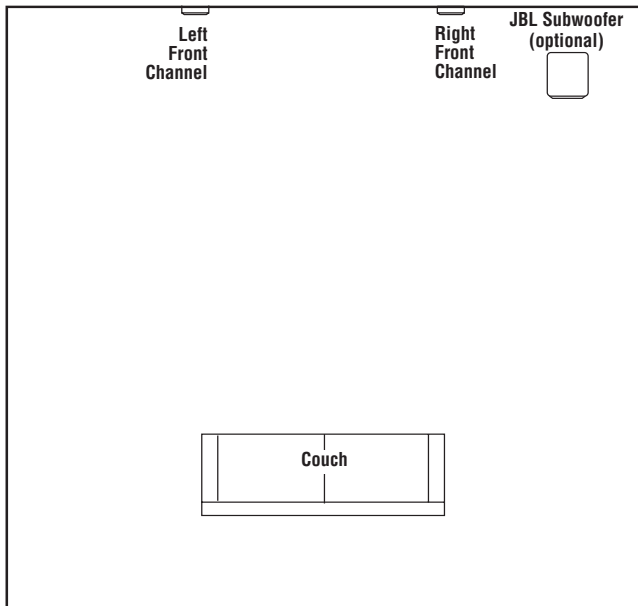

Figure 1.

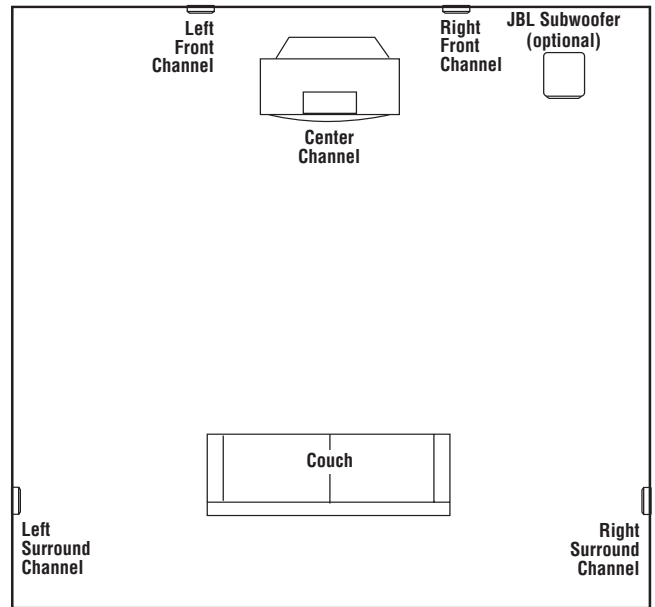

Figure 2. This overhead view shows a typical home theater system arrangement.

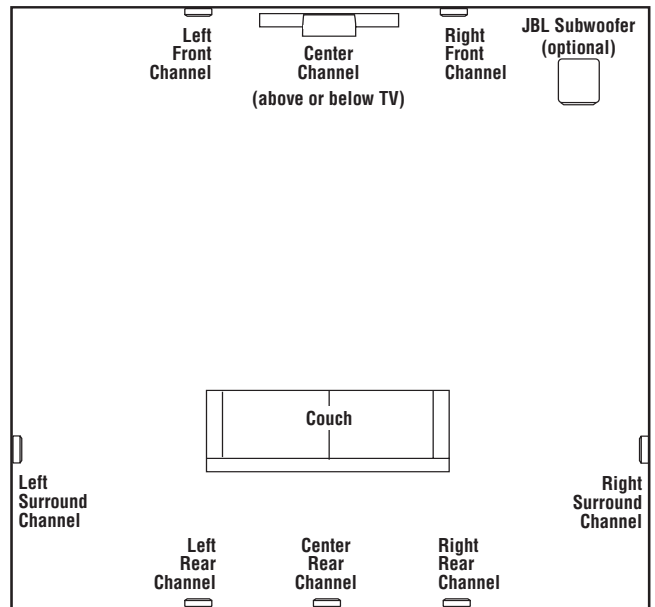

Figure 3. This overhead view shows a 6- or 7-channel home theater system arrangement. Left/right rear channels are for a 7-channel system. Center rear channel is for a 6-channel system.

NOTE: Figures 1, 2 and 3 show recommended speaker locations. You may also follow these general placement suggestions when installing the speakers in the ceiling.

PLACEMENT

STEREO

Before deciding where to place your speakers, survey your room and think about placement, keeping the following points in mind, and using Figure 1, on previous page, as a guide:

- For best results, place the speakers 6'–8' apart.
- When installing in the wall, position each speaker so that the tweeter is as close to ear level as practical.
- Refer to "Home Theater" below if you also plan to use the speakers in a home theater system.

HOME THEATER

For front-channel use, place one speaker on the left and another on the right along either side of the television.

A center channel speaker should go directly above or below the television and can be an in-wall, in-ceiling or freestanding center channel.

For left and right surround channels, place one speaker on the left and another on the right, to the side of or slightly behind the listening area. In 6- or 7-channel configurations, place the rear channel(s) behind the listening position, as shown in Figure 3.

NOTE: A JBL powered subwoofer will add impact and realism to both music and film soundtracks. Contact your JBL dealer for recommendations on subwoofer models for your application.

Proper placement of the speakers is an important step in obtaining the most realistic soundstage possible. These recommendations are for the optimal placement of the loudspeakers. Use these placement recommendations as a guide. Slight variations will not diminish your listening pleasure.

INSTALLATION

The Studio™ L Series in-wall and in-ceiling speakers were designed to be easily installed. However, if you are unable to clearly and fully understand and follow the instructions in this manual, or if you are unsure of your ability to properly install these loudspeakers, please contact your dealer or a qualified installer.

TOOLS NEEDED



Pencil



Phillips #2 screwdriver
(Do not use a powered screwdriver of any kind)

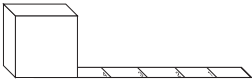

Measuring tape

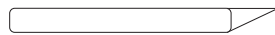

Utility knife

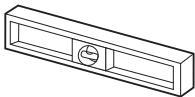

Carpenter's level



Awl

SPEAKER CONNECTIONS

CONNECTION TIPS

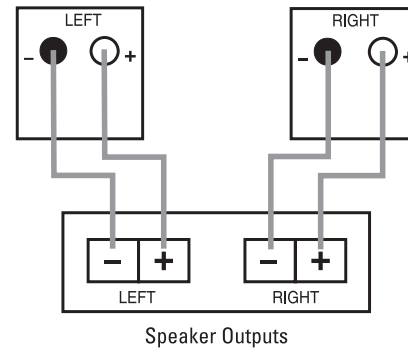
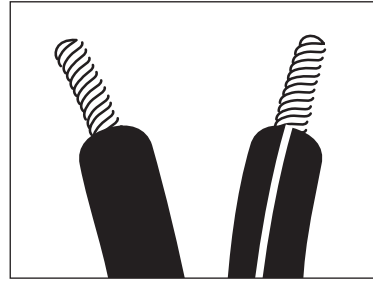

Figure 4.

Wire Length

Up to 100 ft.

Greater than 100 ft.

Recommended Size

16-gauge

12-gauge

TURN OFF ALL POWER

Before completing the installation, you must connect your speakers to your system. First, turn off all audio-system power. Use high-quality speaker wire to make your connections. Use at least #16-gauge speaker wire with polarity coding. Heavier gauge wire is recommended for larger distances. Consult the chart above or your dealer for recommendations. The side of the wire with a ridge or other coding is usually considered positive (+) polarity. Also, consult the owner's manuals that were included with your amplifier or receiver to confirm connection procedures.

Observe polarities when making speaker connections, as shown in Figure 4. Connect each + terminal on the back of the amplifier or receiver to the respective + (red) terminal on each speaker. Connect the – (black) terminals in the same way.

IMPORTANT!

Do not reverse polarities (i.e., + to – , or – to +) when making connections. Doing so will cause poor imaging and diminished bass response. Be certain that positive and negative wire strands are completely isolated to avoid short circuits that may damage your equipment.

EXISTING CONSTRUCTION

L226C, L228C, LS326C, LS328C

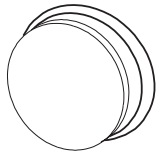

1. Remove the plastic paint shield from the speaker frame.

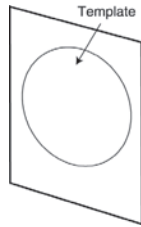

2. Determine the correct speaker location.

NOTE: Use the included template when cutting the drywall.

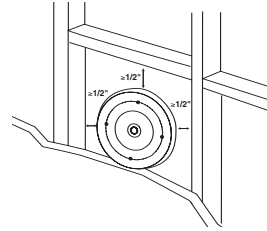

3. **NOTE:** Always allow at least a 1/2" between a wall stud and the speaker cutout, or the locking tabs will not be able to swivel into place.

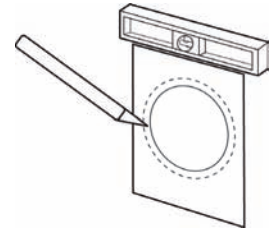

4. Ensure that the drywall or plywood board or other appropriate wallboard is at least 1/2" thick, and confirm that the board material is capable of withstanding the weight of the speaker you will be installing. Cut the drywall.

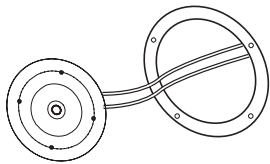

5. Connect the speaker wires to the speaker.

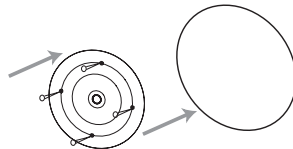

6. Make sure all four locking tabs are properly positioned against the locking tab stops that are located on the speaker frame (see Figure 5 below). After confirming this, carefully place the frame assembly in the wall and confirm that there is no more than 1/8" play between the frame and the wall cutout. After positioning the speaker in the mounting location, back each screw out one full turn (turn counterclockwise).

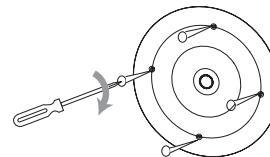

7. Screw down each of the four Phillips-head screws, alternating between the four screws. The locking tabs will swivel into place and secure the unit to the rear surface of the wall panel. Hand-tighten with a nonpowered, straight-handle regular screwdriver only. Do not use a socket wrench, a powered screwdriver, a drill or any other powered tool. Confirm that the speaker is firmly and securely held in place and that all four locking tabs are firmly resting against the wall panel.

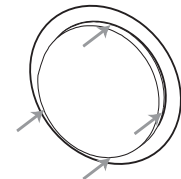

8. Attach the metal grille and logo, if desired.

Figure 5.

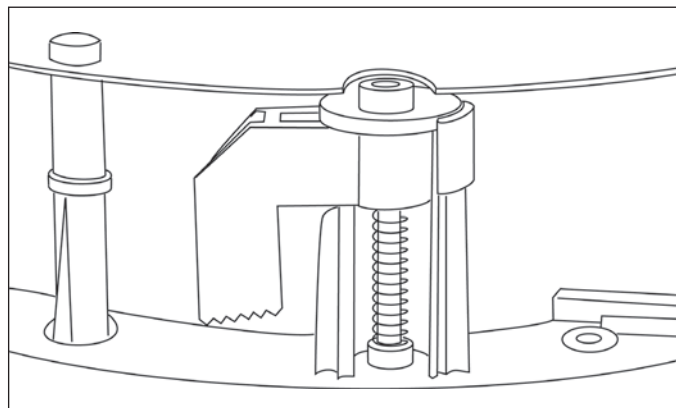

L226W, LS326W

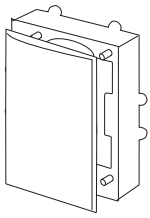

1. Remove the plastic paint shield from the speaker frame.

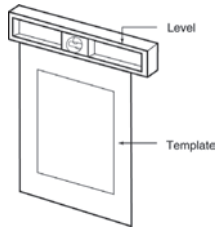

2. Determine the correct speaker location.
NOTE: Use the included template when cutting the drywall.

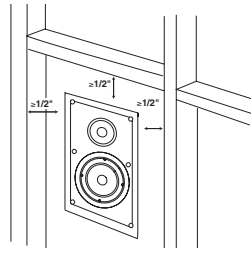

3. **NOTE:** Always allow at least a 1/2" between a wall stud and the speaker cutout, or the locking tabs will not be able to swivel into place.

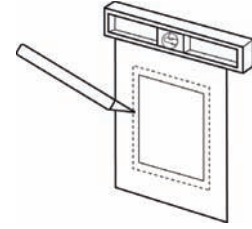

4. Ensure that the drywall or plywood board or other appropriate wallboard is at least 1/2" thick, and confirm that the board material is capable of withstanding the weight of the speaker you will be installing. Cut the drywall.

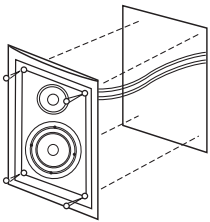

5. Connect the speaker wires to the speaker.

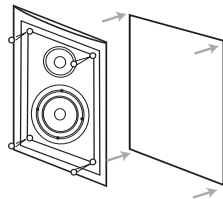

6. Make sure all four locking tabs are properly positioned against the locking tab stops that are located on the speaker frame (see Figure 6 below). After confirming this, carefully place the frame assembly in the wall and confirm that there is no more than 1/8" play between the frame and the wall cutout. After positioning the speaker in the mounting location, back each screw out one full turn (turn counterclockwise).

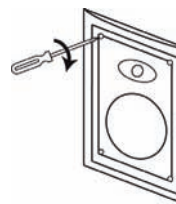

7. Screw down each of the four Phillips-head screws, alternating between the four screws. The locking tabs will swivel into place and secure the unit to the rear surface of the wall panel. Hand-tighten with a nonpowered, straight-handle regular screwdriver only. Do not use a socket wrench, a powered screwdriver, a drill or any other powered tool. Confirm that the speaker is firmly and securely held in place and that all four locking tabs are firmly resting against the wall panel.

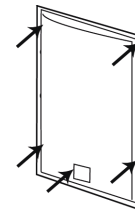

8. Attach the metal grille and logo, if desired.

Figure 6.

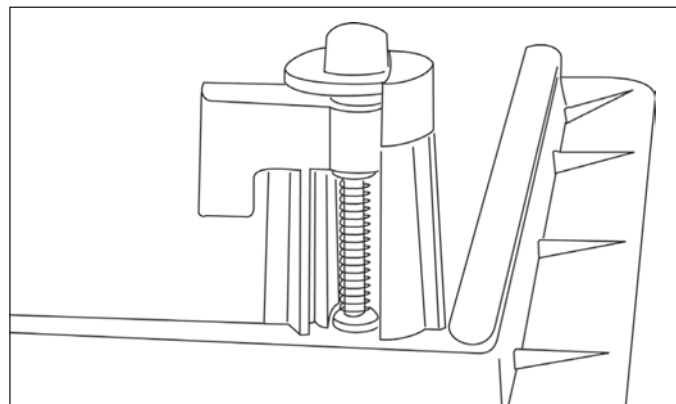

NEW CONSTRUCTION

If you wish to preinstall a rough-in frame before the drywall is installed, you will need to purchase the correct rough-in-frame kit for your model:

Speaker Model	Rough-In-Frame Kit
L226W, LS326W	RIF 6
L226C, LS326C	RIF 6CS
L228C, LS328C	RIF 8C

Detailed installation instructions are supplied with the rough-in kit.

PAINTING THE SPEAKER FRAME AND GRILLE

Studio L in-wall and in-ceiling loudspeakers can be painted to match any décor. If you wish to change their color, the satin finish on the grille and frame will function as a primer coat. Before painting, install the paint shield (inner section of template in the assembly kit) securely into the recess in the baffle. This will protect the speaker components and baffle from paint residue. Use a high-quality spray paint, and apply a thin coat of color. **Be certain the grille perforations remain free of paint. Filling them with paint will diminish the sound quality.**

NOTE: Gently remove the acoustical foam blanket from the grille before painting. Reattach the blanket after the paint has dried.

OPERATION SURROUND MODES

When using the system in a Dolby® Digital or DTS® home theater system, make sure all speakers are set to "Small." When using the Studio L in-wall and in-ceiling speakers in a Dolby Pro Logic® home theater system, make sure the receiver's center channel mode is set to "Normal."

Some Dolby Digital-equipped receivers/processors offer different setup options for each source or surround mode: e.g., CD-stereo, videotape, Dolby or Pro Logic. In each case, follow your equipment's instructions to ensure that the subwoofer (if you have one) output is turned on and that the speakers are set to "Small" in each mode.

TWEETER-LEVEL CONTROL

In most typical listening rooms, this switch should be left in the neutral or "0" position. This setting will deliver the most neutral and balanced sound. In some extreme cases, it may be desirable to slightly boost or cut the tweeter's output, depending upon the room layout, construction and furnishings.

If the room is sparsely furnished, contains large exposed windows or is otherwise very reverberant, you may want to set the control to the "-" (-1.5dB) position. If the room is exceptionally absorbent because it is well furnished or has thick curtains and/or carpet, you may want to increase the tweeter output by setting this switch to the "+" position (+1.5dB).

BOUNDARY COMPENSATION CONTROL LS326W, LS326C, LS328C

This control is designed to be engaged when positioning the loudspeaker within two feet of another surface to eliminate the bass peak caused by the second surface and to maintain a smooth, natural bass response. For example, if you need to install an in-ceiling speaker within two feet of a side wall or corner, it is recommended that the Boundary Compensation control be set to the "On" position. Likewise, if it is necessary to install an in-wall speaker within two feet of the floor, ceiling or corner, the control should be set to the "On" position. In all other installations, the control should typically be set to "Off".

SPECIFICATIONS

Studio L	L226W	L226C	L228C
Frequency Range (-6dB)	30Hz – 20kHz	30Hz – 20kHz	28Hz – 20kHz
Recommended Amplifier Power Range	10 – 125 Watts	10 – 125 Watts	10 – 135 Watts
Sensitivity (2.83V @ 1 meter)	89dB	89dB	90dB
Nominal Impedance	8 Ohms	8 Ohms	8 Ohms
Crossover Frequency	3,000Hz; 24dB/Octave	2,500Hz; 18dB/Octave	2,500Hz; 18dB/Octave
Low-Frequency Driver	6-1/2" (165mm) Aluminum cone	6-1/2" (165mm) Aluminum cone	8" (200mm) Aluminum cone
High-Frequency Driver	1" (25mm) Titanium-laminate	1" (25mm) Titanium-laminate	1" (25mm) Titanium-laminate
External Dimensions (W x H)	8-1/2" x 11" (216mm x 280mm)	Diameter: 9-3/16" (233mm)	Diameter: 10-7/8" (276mm)
Mounting Cutout Size (W x H)	7" x 9-1/2" (178mm x 241mm)	Diameter: 7-7/8" (200mm)	Diameter: 9-1/2" (241mm)
Mounting Depth	3-9/16" (90mm)	4-1/8" (104mm)	4-5/8" (117mm)
Weight (net)	3.5 lb (1.6kg)	3.5 lb (1.6kg)	5.8 lb (2.6kg)

Studio L	LS326W	LS326C	LS328C
Frequency Range (-6dB)	30Hz – 30kHz	30Hz – 30kHz	28Hz – 30kHz
Recommended Amplifier Power Range	10 – 135 Watts	10 – 135 Watts	10 – 150 Watts
Sensitivity (2.83V @ 1 meter)	89dB	89dB	90dB
Nominal Impedance	8 Ohms	8 Ohms/channel	8 Ohms
Crossover Frequency	3,000Hz; 24dB/Octave	2,500Hz; 18dB/Octave	2,500Hz; 18dB/Octave
Low-Frequency Driver	6-1/2" (165mm) Aluminum cone	6-1/2" (165mm) Aluminum cone	8" (200mm) Aluminum cone
High-Frequency Driver	1" (25mm) Titanium	1" (25mm) Titanium	1" (25mm) Titanium
External Dimensions (W x H)	8-1/2" x 11" (216mm x 280mm)	Diameter: 9-3/16" (233mm)	Diameter: 10-7/8" (276mm)
Mounting Cutout Size (W x H)	7" x 9-1/2" (178mm x 241mm)	Diameter: 7-7/8" (200mm)	Diameter: 9-1/2" (241mm)
Mounting Depth	3-9/16" (90mm)	4-1/8" (104mm)	4-5/8" (117mm)
Weight (net)	3.5 lb (1.6kg)	3.5 lb (1.6kg)	5.8 lb (2.6kg)

Declaration of Conformity



We, Harman Consumer Group, Inc.
2, route de Tours
72500 Château du Loir
France

declare in own responsibility that the products described in this
owner's manual are in compliance with technical standards:

EN 61000-6-3:2001
EN 61000-6-1:2001

Laurent Rault
Harman Consumer Group, Inc.
Château du Loir, France 8/07

Features, specifications and appearance are subject to change without notice.

JBL is a registered trademark, and Pro Sound Comes Home and Studio are trademarks,
of Harman International Industries, Incorporated.

Dolby and Pro Logic are registered trademarks of Dolby Laboratories.

DTS is a registered trademark of DTS, Inc.



PRO SOUND COMES HOME™

Harman Consumer Group, Inc., 250 Crossways Park Drive, Woodbury, NY 11797 USA
8500 Balboa Boulevard, Northridge, CA 91329 USA
516.255.4JBL (4525) (USA only) www.jbl.com
© 2007 Harman International Industries, Incorporated. All rights reserved.
Part No. 406-000-05529-E

H A Harman International Company